

Questions or Concerns Contact Canarm At:

1-800-265-1833 (English) or 1-800-567-2513 (French) Monday Through Friday 8:00am - 5:00pm E.S.T.



"INSTRUCTIONS PERTAINING TO RISK OF FIRE OR INJURY TO PERSONS"
"READ ALL INSTRUCTIONS"
"IMPORTANT SAFETY INSTRUCTIONS"
"SAVE THESE INSTRUCTIONS"

TOOLS AND MATERIALS REQUIRED:



Phillips Screwdriver



Wire Cutters



Pliers



Wrench

Wiring supplies as required by the Canadian Electrical Code and/or the Quebec Electrical code

SAFETY PRECAUTIONS:

1. **TURN OFF ELECTRICAL POWER BEFORE STARTING INSTALLATION OF LIGHT FIXTURE.**
2. **THIS PRODUCT MUST BE INSTALLED IN ACCORDANCE WITH THE APPLICABLE INSTALLATION CODE BY A PERSON FAMILIAR WITH THE CONSTRUCTION AND OPERATION OF THE PRODUCT AND THE HAZARDS INVOLVED.**
3. **FIRMLY ATTACH THE FIXTURE GROUND WIRE (BARE COPPER) TO THE MOUNTING BRACKET WITH THE GROUND SCREW (BY WRAPPING AROUND THE GROUND SCREW) AND THEN CONNECT IT TO THE HOUSE SUPPLY GROUND WIRE WITH A WIRE NUT.**

NOTE: Product May Not Look Exactly As Shown In Figures.

INSTALLATION:

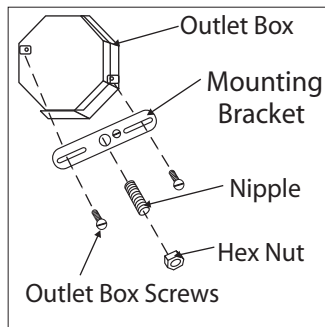

1. Attach the mounting bracket to the outlet box using electrical box screws. Attach the nipple to the mounting bracket and adjust until it will clear the canopy when assembled (Place the canopy over the nipple and tighten the upper connector onto the nipple until snug. The upper connector should hold the canopy snug to the ceiling). Lock the nipple in the correct position using the hex nut.

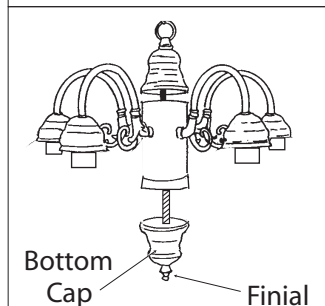

2. Attach the bottom cap to the fixture using the decorative finial.

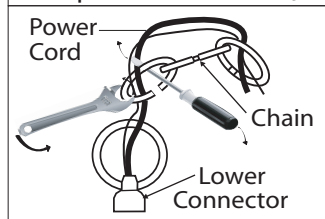

3. To attach chain loop to light fixture, use a screwdriver and wrench to open and close chain loop. Ensure to close the opening. Weave the power cord and ground wire through the links in the chain.

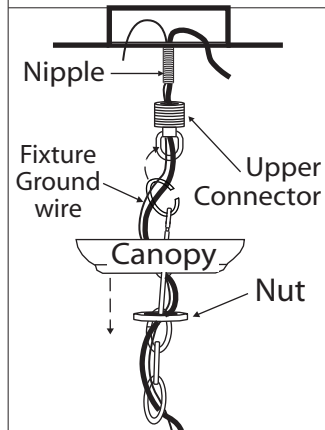

4. Loosen the nut on the upper connector and slide it down the chain towards the lower connector. Slide the canopy down the chain towards the lower connector. Feed the wire through nut, canopy, the upper connector and onto the nipple. Tighten the upper connector onto the nipple. Spread the other end of the chain open and fasten to the upper connector. Ensure to close the opening.

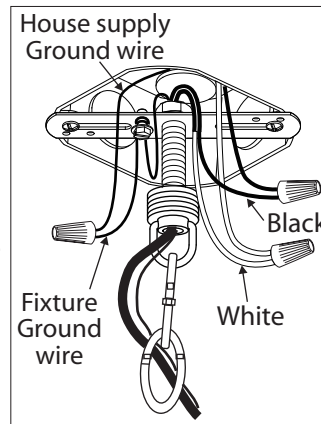

5. Firmly attach the fixture ground wire (bare copper) to the mounting bracket with the ground screw (by wrapping around the ground screw) and then connect it to the house supply ground wire with a wire nut. Connect the black wire (or wire marked "SPT-1") from the fixture to the black wire in the electrical box and connect the white wire from the fixture to the white wire in the electrical box.

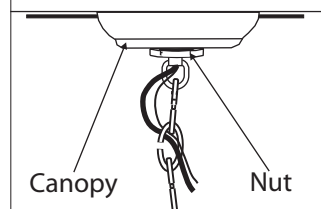

6. Once connections of wires are completed, carefully tuck wires and wire nuts into the outlet box making sure no bare wire (on the black and white) is visible at the wire nuts. Slide canopy into position and tighten in place by nut into position.

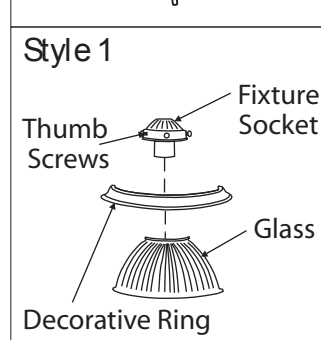

7. **"Style 1"** - Place the decorative ring over the glass shade. Attach the glass shade to the fixture socket using the thumb screws (tighten with fingers only).

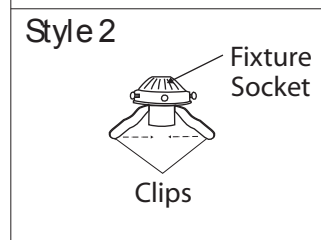

"Style 2" - Squeeze the two clips together around the socket. Slide the glass over the clips, then push the glass up snug to the fixture socket.

8. Install proper bulb type and wattage (not included).